

## HVR1B05

- High Voltage FORM B Relay
- Coil Voltage 05V
- Breakdown up to 4.0KVDC

[Outline Dimension]

Unit: mm

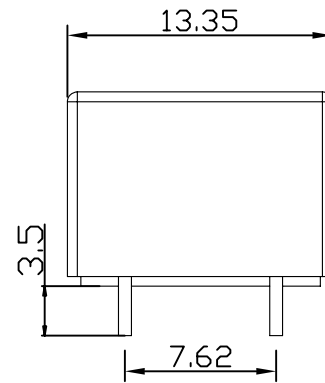
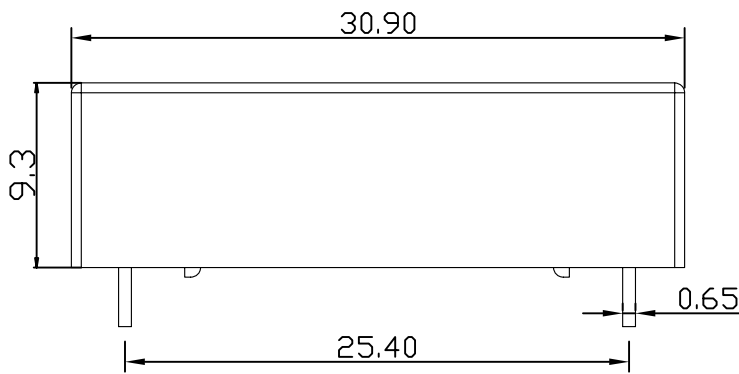

[Pin Layout]



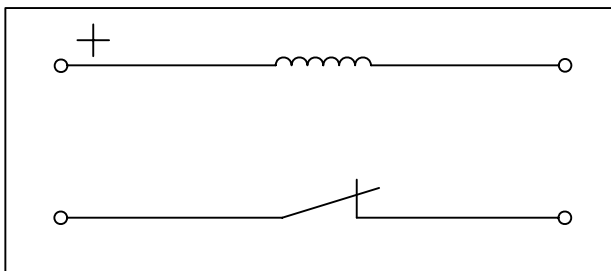

[Top View]



Order Information

HVR1B05

Coil Parameters		Relay Parameters	
1 Nominal coil voltage	5.0 VDC	1 Min Breakdown Voltage	4.0K VDC
2 Max Operating voltage	7.0 VDC	2 Dielectric Strength coil/contact	4.0K VDC
3 Max Pull-in voltage	4.0 VDC	3 Insulation Resistance coil/contact	1.00E+12ohm
4 Min Drop-out voltage	0.5 VDC	4 Operate Time, incl. Bounce	1.0ms
5 Coil Resistance	150ohm	5 Reset Time	0.1ms
Contact Parameters		6 Capacitance Across Contacts	0.2pF
1 Max Contact Rating	100 W	7 Storage Temperature	-35~+105°C
2 Max Switch Voltage	1000VAC peak/VDC	8 Operating Temperature	-20~+70 °C
3 Max Switch Current	1.0 A	9 Soldering Temperature	5 sec. max 260°C
4 Max Carrying Current	2.5 A		
5 Min Breakdown Voltage	4.0K VDC		
6 Max Contact Resistance	150mohm		

Version: 01	Designed by		TITLE	 
	Checked by		High Voltage Reed Relay	
	Approved by		P/N	 
	Date	2013-07-10	HVR1B05	