

1. 管包装信息

1.1. 管包装示意图如下所示:

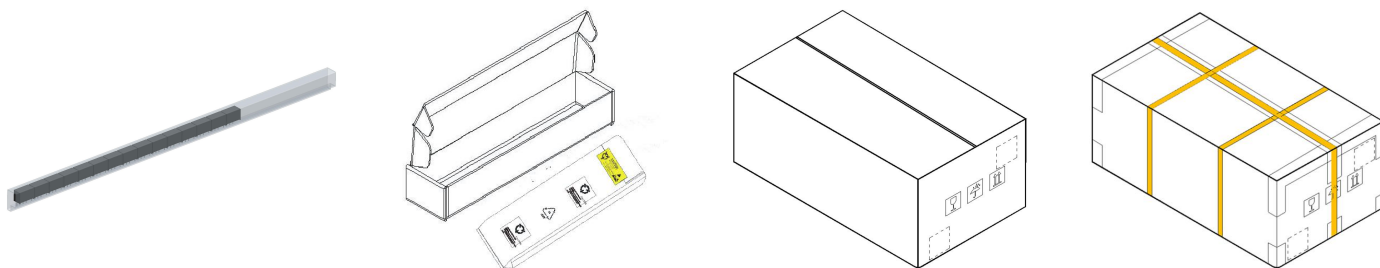

管包装信息预览表

No.	管包装 包装包号	包装材料用量				满箱产 品数量(pcs)	最小包装 (短管) (pcs)	推荐起订量 (pcs)
		PVC 管 (pcs)	静电袋 (pcs)	内箱 (pcs)	外箱 (pcs)			
1	58000145	64	16	4	1	3200	23	800
2	58000150	64	16	4	1	960	7	240
3	58000152	96	12	4	1	2400	12	600
4	58040012	96	16	4	1	2784	13	696
5	58040014	96	16	4	1	2400	11	600
6	58200001	128	8	2	1	3200	12	1600
7	58200003	128	8	2	1	5504	20	2752
8	58200005	128	8	2	1	3840	14	1920
9	58200007	256	16	4	1	3328	6	832
10	58200009	160	16	4	1	4000	11	1000
11	58200011	160	16	4	1	6400	18	1600
12	58200013	120	12	4	1	3000	11	750
13	58200017	72	12	4	1	1080	7	270
14	58200019	240	12	4	1	7680	15	1920
15	58200021	240	12	4	1	9120	18	2280
16	58210024	240	12	4	1	9120	18	2280
17	58200023	24	12	4	1	216	4	54
18	58200024	24	12	4	1	288	5	72
19	58200035	24	12	4	1	456	9	114
20	58210039	24	12	4	1	432	8	108
21	58200025	144	12	4	1	4032	13	1008
22	58200027	240	12	4	1	6000	12	1500
23	58200029	256	16	4	1	6400	12	1600
24	58010114	96	12	4	1	2496	12	624
25	58200044	120	12	4	1	2520	10	630
26	58200045	128	16	4	1	3328	12	832
27	58210001	48	12	4	1	864	8	216
28	58210003	48	12	4	1	912	9	228
29	58210004	120	12	4	1	2640	10	660

管包装信息预览表

No.	管包装	包装材料用量				满箱产品数量(pcs)	最小包装(短管)(pcs)	推荐起订量(pcs)
	包装包号	PVC管(pcs)	静电袋(pcs)	内箱(pcs)	外箱(pcs)			
30	58200015	120	12	4	1	2160	8	540
31	58210006	120	12	4	1	2280	9	570
32	58210008	72	12	4	1	1080	7	270
33	58210010	72	12	4	1	1080	7	270
34	58210011	48	12	4	1	1152	11	288
35	58210013	48	12	4	1	1008	10	252
36	58210015	96	12	4	1	2016	10	504
37	58210017	120	12	4	1	1800	7	450
38	58210019	72	12	4	1	1512	10	378
39	58210021	80	8	4	1	3520	20	880
40	58210037	120	6	2	1	6840	26	3420
41	58210023	240	12	4	1	7680	15	1920
42	58210025	72	12	4	1	3528	23	882
43	58210027	96	16	4	1	4224	20	1056
44	58210029	128	16	4	1	2816	10	704
45	58210030	48	12	4	1	720	7	180
46	58210032	32	16	4	1	608	9	152
47	58210035	96	8	4	1	2496	12	624
48	58220001	48	16	4	1	624	6	156
49	58220003	16	8	4	1	304	9	76
50	58220014	32	16	4	1	704	10	176
51	58220015	64	16	4	1	1856	13	464
52	58200048	48	16	4	1	912	9	228
53	58200049	16	8	4	1	144	4	36
54	58200050	12	6	4	1	192	5	48
55	58200051	16	8	4	1	304	9	76
56	58240002	120	12	4	1	2280	9	570
57	58200039	24	8	4	1	744	14	186
58	58000144	240	12	4	1	6240	12	1560

2. 珍珠棉包装信息

2.1. 珍珠棉包装示意图如下所示:

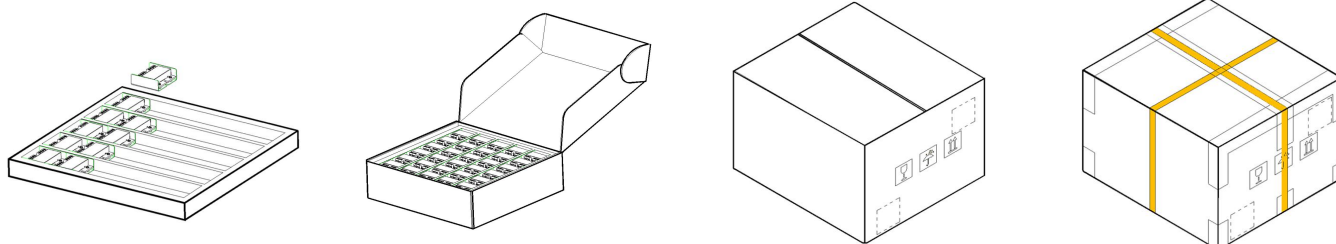

珍珠棉包装信息预览表

No.	珍珠棉包装	包装材料用量				满箱产 品数量(pcs)	最小 包装量(pcs)	推荐 起订量(pcs)
	包装包号	珍珠棉 (pcs)	棉盖 (pcs)	内箱 (pcs)	外箱 (pcs)			
1	58200037	6	2	2	1	120	20	60
2	58200038	6	2	2	1	96	16	48
3	58220012	4	2	2	1	96	24	48
4	58220013	4	4	2	1	48	12	24
5	58250002	8	2	2	1	448	56	224
6	58220009	8	2	2	1	32	4	16
7	58220005	6	2	2	1	210	35	105
8	58230001	6	2	2	1	360	60	180
9	58220011	6	2	2	1	210	35	105
10	58220007	6	2	2	1	240	40	120
11	58220006	6	2	2	1	120	20	60
12	58200040	4	2	2	1	120	30	60
13	58220017	4	4	2	1	80	12	40
14	58220010	4	2	2	1	48	12	24
15	58220029	4	2	2	1	32	8	16
16	58220018	6	2	2	1	720	120	360
17	58220019	4	2	2	1	60	15	30
18	58220020	4	2	2	1	40	10	20
19	58220021	4	2	2	1	48	12	24
20	58220022	4	2	2	1	96	24	48
21	58220023	8	2	2	1	480	60	240
22	58220025	8	2	2	1	480	60	240
23	58220026	8	2	2	1	480	60	240
24	58220031	8	2	2	1	64	8	32
25	58010113	8	2	2	1	192	24	96
26	58020022	6	6	2	1	36	6	18
27	58200055	6	2	2	1	360	60	180
28	58220032	6	2	2	1	120	30	60
29	58200036	4	2	2	1	288	72	144
30	58200069	8	2	2	1	128	16	64
31	58200061	4	2	2	1	64	16	32
32	58000155	4	2	2	1	160	40	80
33	58220034	15	0	0	1	15	1	1
34	58010116	8	2	2	1	1120	140	560
35	58010119	8	2	2	1	448	56	224
36	58020023	12	0	12	1	24	2	2
37	58020024	6	2	2	1	546	91	273
38	58210050	4	2	2	1	16	4	8

珍珠棉包装信息预览表

No.	珍珠棉包装	包装材料用量				满箱产品数量(pcs)	最小包装量(pcs)	推荐起订量(pcs)
	包装包号	珍珠棉(pcs)	棉盖(pcs)	内箱(pcs)	外箱(pcs)			
39	58210051	5	1	0	1	5	1	5
40	58210060	4	2	2	1	8	2	4
41	58210063	10	2	2	1	630	63	315
42	58210065	10	2	2	1	350	35	175
43	58210067	8	0	8	1	8	1	1
44	58220030	4	2	2	1	32	8	16
45	58220035	4	10	2	1	24	6	12
46	58220040	12	0	12	1	12	1	1
47	58220041	12	0	12	1	12	1	1
48	58220042	4	4	2	1	72	18	36
49	58220043	4	2	2	1	24	6	12
50	58220047	4	4	2	1	16	4	8
51	58220050	9	0	9	1	9	1	1
52	58220051	6	2	2	1	168	28	84
53	58220052	6	2	2	1	144	24	72
54	58240010	8	2	2	1	800	100	400

3. 卷盘包装信息

3.1. 卷盘包装示意图

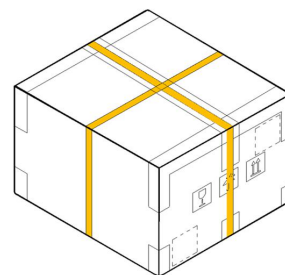
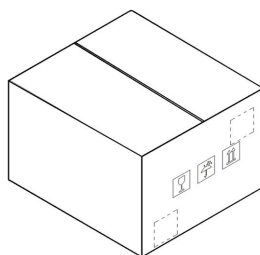
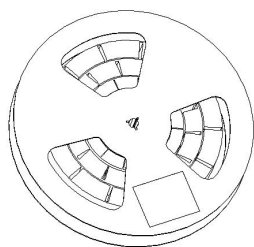

卷盘包装信息预览表

No.	卷盘包装	包装材料用量						满箱产品数量(pcs)	最小包装量(pcs)	推荐起订量(pcs)
	包装包号	载带(pcs)	盖带(pcs)	干燥剂(pcs)	静电袋(pcs)	内箱(pcs)	外箱(pcs)			
1	58210034	6	6	12	6	2	1	3000	500	500
2	58200032	8	8	16	8	2	1	4000	500	500
3	58200031	8	8	16	8	2	1	4000	500	500
4	58200033	6	6	12	6	2	1	2400	400	400
5	58200034	6	6	12	6	2	1	3000	500	500
6	58200052	6	6	12	6	2	1	1200	200	200

卷盘包装信息预览表

No.	卷盘包装	包装材料用量						满箱产品数量(pcs)	最小包装量(pcs)	推荐起订量(pcs)
	包装包号	载带(pcs)	盖带(pcs)	干燥剂(pcs)	静电袋(pcs)	内箱(pcs)	外箱(pcs)			
7	58200053	6	6	12	6	2	1	3000	500	500
8	58210036	6	6	12	6	2	1	1500	250	250
9	58200054	6	6	12	6	2	1	3000	500	500
10	58210038	8	8	16	8	2	1	4000	500	500
11	58010115	8	8	16	8	2	1	1200	200	200
12	58210058	6	6	12	6	2	1	1800	300	300
13	58210059	2	2	4	2	2	1	300	150	150
14	58210064	8	8	8	8	2	1	6400	800	800
15	58240008	6	6	12	6	2	1	2400	400	400
16	58240009	4	4	8	4	2	1	800	200	200
17	58240012	4	4	8	4	2	1	1200	300	300

4. 内盒（彩盒）包装信息

4.1. 内盒(彩盒)包装示意图如下所示：

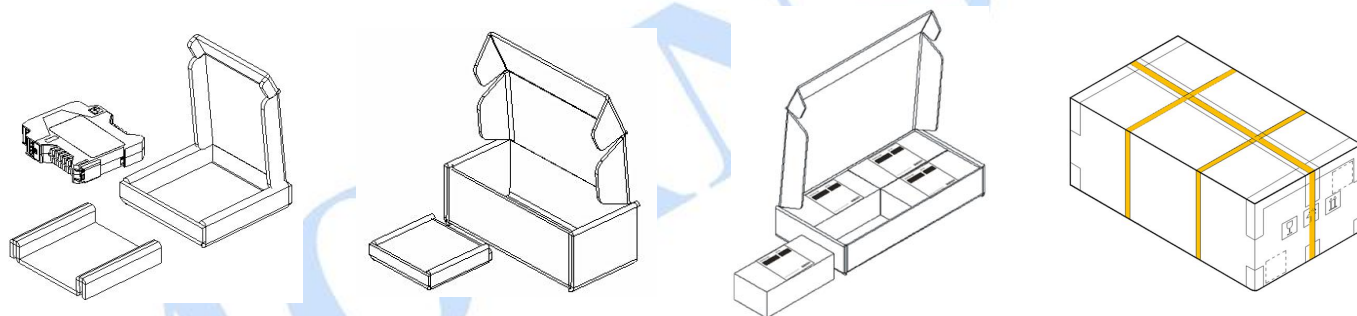

彩盒包装信息预览表

No.	彩盒包装	包装材料用量							满箱产品数量(pcs)	最小包装量(pcs)	推荐起订量(pcs)
	包装包号	静电袋(pcs)	干燥剂(pcs)	内卡(pcs)	彩盒(pcs)	内盒(pcs)	内箱(pcs)	外箱(pcs)			
1	58220008	96	48	48	48	8	2	1	96	2	2
2	58220016	26	26	26	26	0	0	1	26	1	1
3	58240001	48	48	48	48	8	2	1	48	1	1
4	58040010	48	48	48	48	8	2	1	48	1	1
5	58220028	20	20	20	0	20	0	1	20	1	1
6	58220024	15	15	15	15	15	0	1	15	1	1
7	58240007	48	48	48	48	48	0	1	48	1	1
8	58200041	0	0	20	0	0	4	1	80	20	20
9	58200042	48	48	48	48	48	8	1	48	1	1
10	58220039	22	22	22	0	22	0	1	22	1	1
11	58220045	22	22	0	0	22	0	1	22	1	1

5. 吸塑托盘包装信息

5.1. 吸塑托盘包装示意图如下所示：

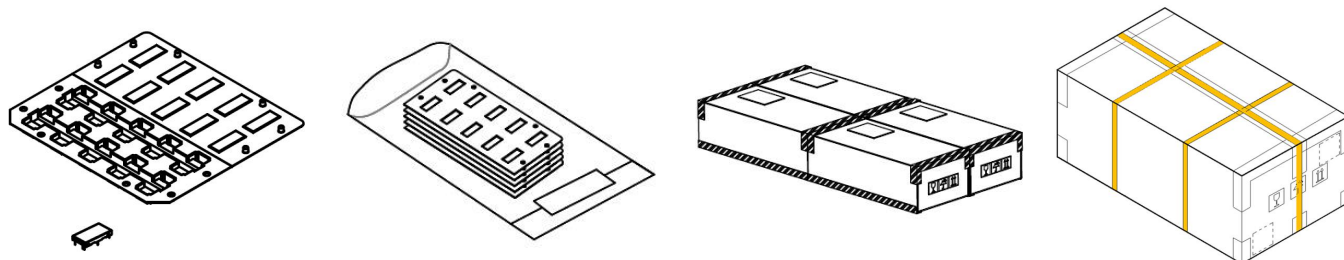

彩盒包装信息预览表

No.	吸塑托盘包装	包装材料用量					满箱产品数量(pcs)	最小包装量(pcs)	推荐起订量(pcs)
	包装包号	吸塑托盘(pcs)	干燥剂(pcs)	静电袋(pcs)	内箱(pcs)	外箱(pcs)			
1	58210054	20	8	4	4	1	200	10	50
2	58210056	20	8	4	4	1	200	10	50

广州金升阳科技有限公司

地址：广东省广州市萝岗区科学城科学大道科汇发展中心科汇一街 5 号

电话：86-20-38601850

传真：86-20-38601272

E-mail: sales@mornsun.cn

MORNSUN®